

STEREO POWER AMPLIFIER

KAC-821

INSTRUCTION MANUAL

KENWOOD

FILE

BRIDGEABLE

©PRINTED IN JAPAN B50-7910-10(E)(T)
92/12 11 10 9 8 7 6 5 4 3 2

Take the time to read through this instruction manual. Familiarity with installation and operation procedures will help you obtain the best performance from your new power amplifier.

For your records

Record the serial number found on the bottom of the unit in the spaces designated on the warranty card and in the space provided below. Refer to the model and serial numbers whenever you call upon your KENWOOD dealer for information or service on this product.

Model KAC-821 Serial number _____

ACCESSORY

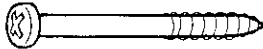
No.	Part name	External View	Number of units
①	Tapping screws ($\phi 5 \times 50$)		4

TROUBLESHOOTING GUIDE

What often appears to be a malfunction is often due to user error in operation or connection. When trouble occurs with your unit, please check the following before calling for service.

Symptom	Cause	Remedy
The sound level is low. (No sound from one side.)	A speaker cord has become unconnected.	Check the speaker cord connections.
The sound quality is bad. (The sound is distorted.)	1. The speakers are connected to the same wires. 2. A speaker cord is pinched by a screw in the car body.	1. Connect each speaker terminal to its respective speaker output. 2. Check the speaker wiring.

SPECIFICATIONS

Specifications subject to change without notice.

Audio section

Max Power Output (1 kHz, 4 Ω)

Normal	140 W + 140 W
Bridged	280 W

Power Output

Normal (20 Hz ~ 20 kHz, 4 Ω , less than 0.5% THD)	75 W + 75 W
Bridged (1 kHz, 4 Ω , 0.5% THD)	150 W

Output Power

Normal (1 kHz, 2 Ω , 0.5% THD)	75 W + 75 W
---	-------------

Frequency Response (-3 dB)

.....	2 Hz ~ 100 kHz
Sensitivity (rated output) MAX.	0.1 V
MIN.	5.0 V

Signal to Noise Ratio

.....	105 dB
-------	--------

Input Impedance

.....	10 k Ω
-------	---------------

Damping Factor (100 Hz)

.....	More than 200
-------	---------------

Sub Woofer Frequency

.....	30 ~ 150 Hz (variable)
-------	------------------------

General

Operating Voltage

.....	14.4 V (11 ~ 16 V allowable)
-------	------------------------------

Current Consumption (MAX.)

.....	20 A
-------	------

Dimensions (W x H x D)

.....	230 x 50 x 300 mm (9-1/16 x 1-15/16 x 11-13/16 in.)
-------	--

Weight

.....	3.5 kg (8.8 lb)
-------	-----------------

INSTALLATION

1. Installation

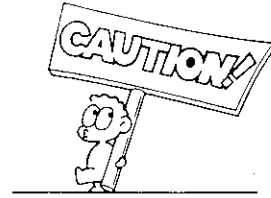
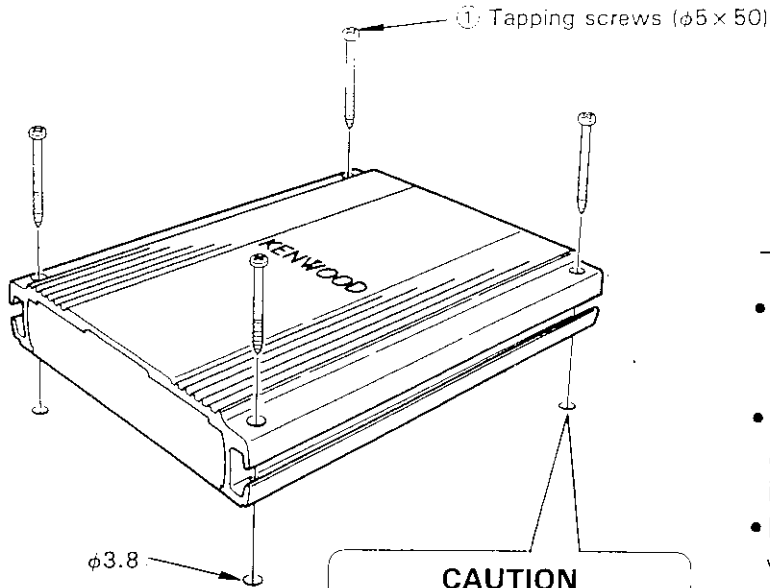

CAUTION
When making the hole, do not damage the fuel tank, brake tube, wiring harnesses, etc. on the other side.

- When installing to the car, install the unit securely for safety driving.
- Use screws supplied as accessories when installing the unit.
- Install the unit in a well-ventilated place and do not place the (heavy) object on it.

2. Installation location

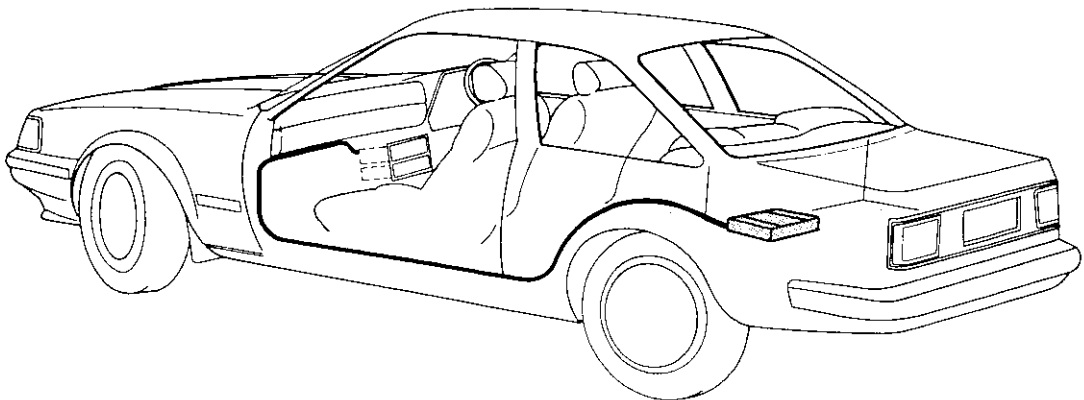

- Since the power amplifier has no parts which require operation, it can be installed at a position away from the driver's seat without any hinderances. As generally accepted positions for its installation, places such as inside the trunk, etc. can be considered.
- Use the extension cables. CA-8L (0.5 m), CA-18L (1 m), CA-28L (2 m), CA-48L (4 m), and CA-68L (6 m) (optional) when the connected models are to be installed away from the power amplifier.

USE OF THE OPERATION PANEL ACCORDING TO SYSTEM TYPE

• Input sensitivity control

The input sensitivity control adjusts the input sensitivity within a range of 0.1 V to 5.0 V continuously, enabling expansion with various systems. This unit has been set for 0.3V.

KENWOOD head unit preout level (MAX.)	Amplifier input sensitivity
300 mV	0.1 V
1 V	0.3~0.5 V

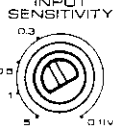

• Mode switch

Set this switch according to the impedance of the speakers or the output method, as shown below.

When 4-ohm speakers are connected When 2-ohm speakers are connected When using a bridged output (see below)

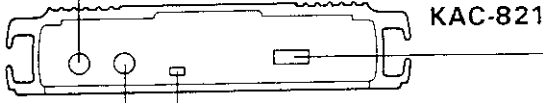
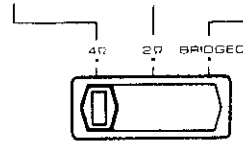

• Sub woofer system

By setting the switch on the right to ON, you can set the output of this unit for sub woofer output (monaural output). The control on the left can be used to adjust the sub woofer cut-off frequency.

■ This unit is provided with a bridged output function which enables you to double the unit's power output. Since the output becomes monaural when the bridged output function is used, systems can be configured such as those shown below. (for 4 Ω speakers)

• When using a KENWOOD DIN output system:

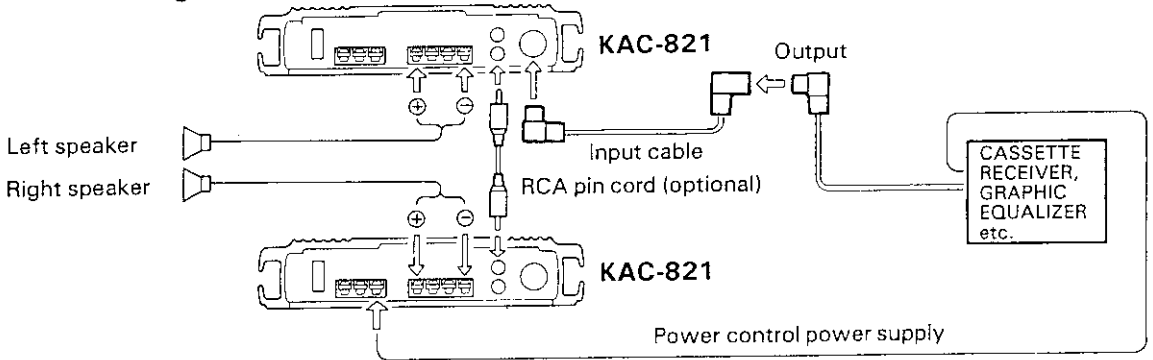

• When using an RCA pin-plug cord output system:

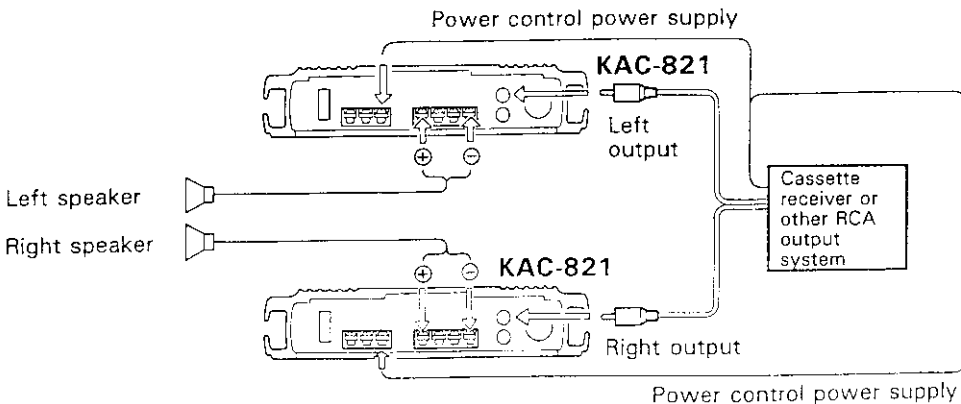

CONNECTIONS

INSTALL MANNER

1. Before installation and wiring, remove the (-) terminal of the battery to prevent short-circuiting.
2. Connect the input and output cords of the system.
3. Connect the ground to the metal chassis of the car.
4. Connect the power supply lead.
5. Install the set and after confirming the installation and wirings are correct, connect the (+) terminal of the battery.



- If a fuse is blown, first check that the associated wires are not short-circuited then replace the fuse with a new one having the same capacity.

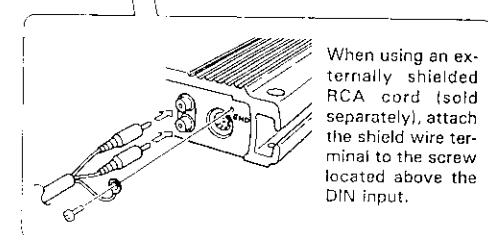
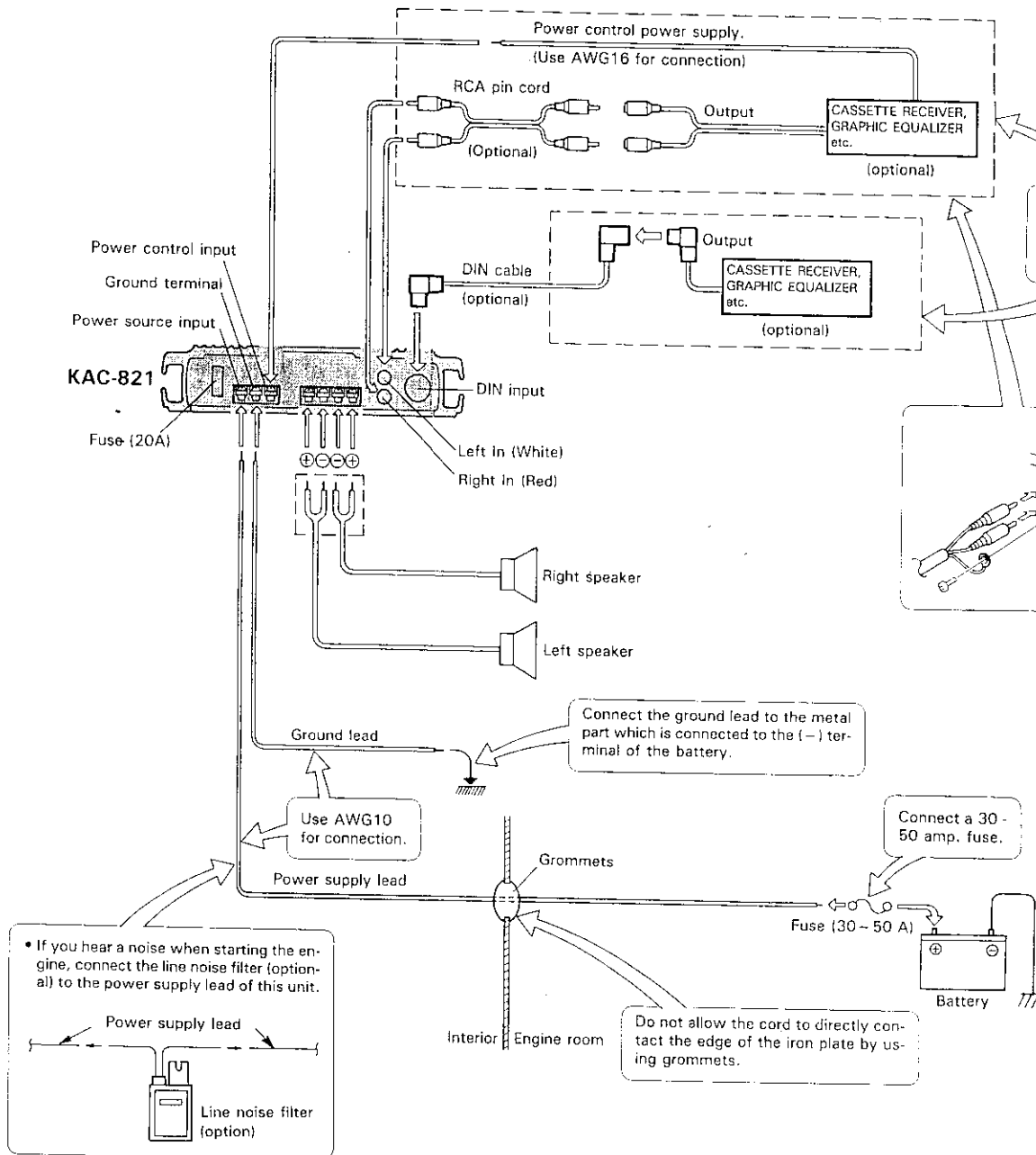
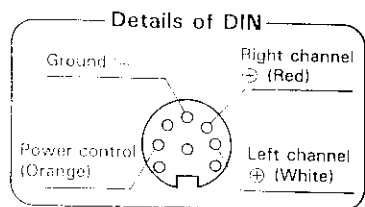

WARNING

TO PREVENT ELECTRIC SHOCK,
FIRE AND OTHER INJURY.
PLEASE NOTE THE FOLLOWINGS:

- To keep good ventilation, do not put anything on top of the unit.

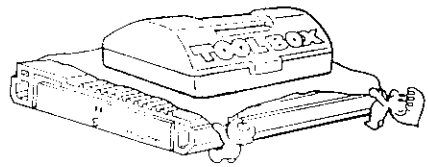

- The unit is designed to be connected to 12 V DC and negative grounding.

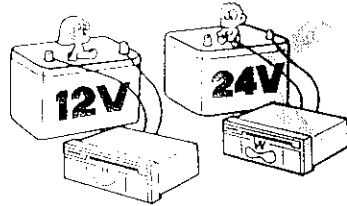

- Do not open enclosure, such as front panel, top or bottom cover.

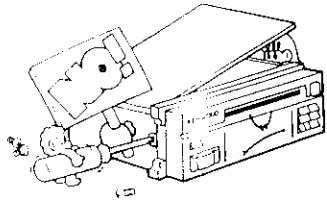

- Do not drop pieces of metal, needles, coins and other electrically conductive materials into the unit.

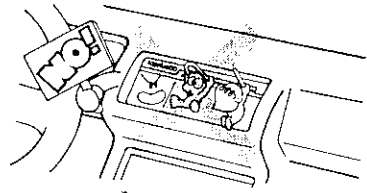

- Do not place the unit where it will be exposed to direct sunlight or close to a heating device.

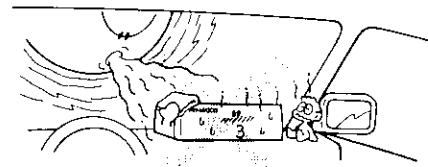

- Do not dash water on the unit.

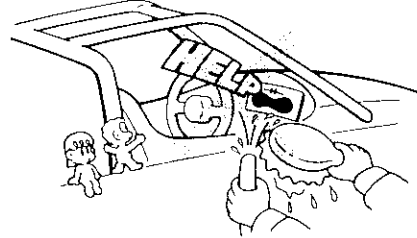

- Do not place the unit in areas of excessive dust, high humidity or on unstable surfaces.

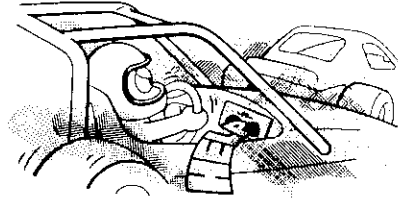

CLEANING

1. Turn the power off, before cleaning the unit.
2. Do not use any type of abrasive pad, thinner, benzene and any such kind of objects.
3. Wipe the front panel and other exterior surfaces of the unit with a soft dry cloth or a soft cloth lightly moistened with a neutral detergent.

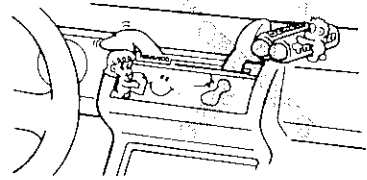

- If an abnormal smell or smoke is detected, immediately turn the power off.



- If you have difficulty in installing the set in your car, please contact your KENWOOD dealer.